

Isolated Neutral Kits

All kits include isolating blocks and hardware to be installed under existing neutral bar

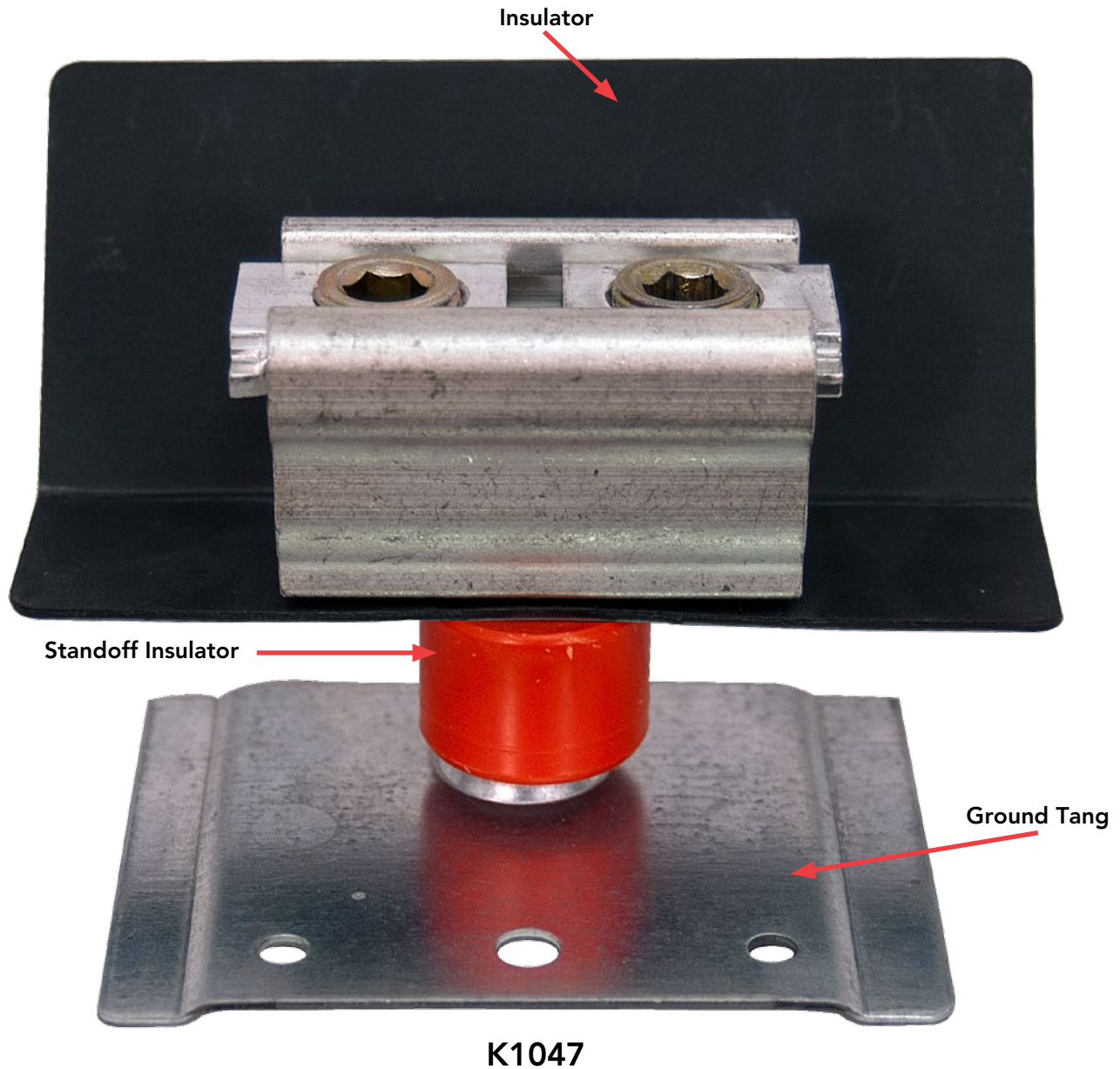

Utility requirements for this equipment may vary. Always consult the serving utility for their requirements before ordering or installing equipment.



Isolated Neutral Kits

All kits include isolating blocks and hardware to be installed under existing neutral bar

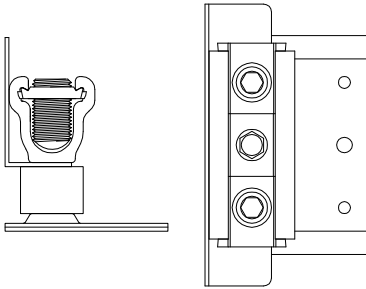

K1047

K1047

200 amp

For use with the following series:

1854, 2046, 2145, 2810, 3061, 3328, 4701,
4788, 4910, 5127, 7422, 7423, 8606, 9701, 9707

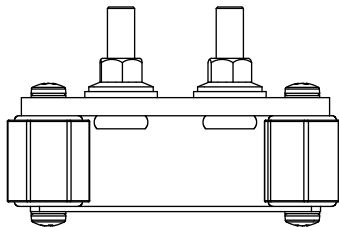
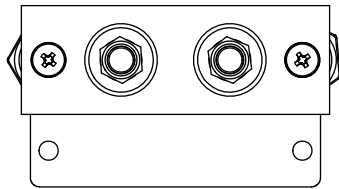

K5977

K5977

320 amp

For use with the following series:

2120, 2448, 2594, 2827, 4013, 4168, 4257,
4260, 4487, 4596, 4741, 4776, 4980, 5036

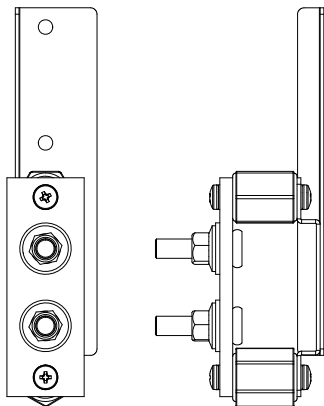

K5978

K5978

320 amp

For use with the following series:

1129*, 1729, 1797, 1897, 3000

*Cannot be used on U1129 with -MVE suffix



Utility requirements for this equipment may vary. Always consult the serving utility for their requirements before ordering or installing equipment.

Isolated Neutral Kits

All kits include isolating blocks and hardware to be installed under existing neutral bar

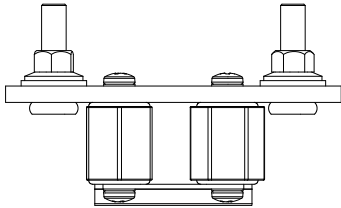
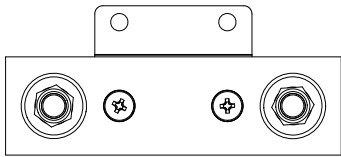

K5979

K5979

320 amp

For use with the following series:

4505, 4702, 5740

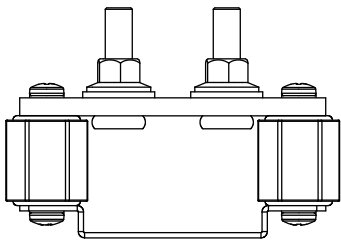

K5980

K5980

320 amp

For use with the following series:

5161

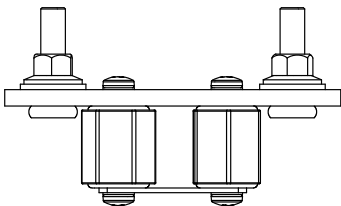
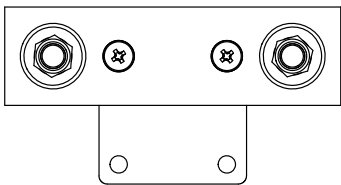

K5984

K5984

320 amp

For use with the following series:

4342, 4362, 4778, 4911, 5786

Utility requirements for this equipment may vary. Always consult the serving utility for their requirements before ordering or installing equipment.



MILBANK
ENERGY AT WORK

Isolated Neutral Kits

All kits include isolating blocks and hardware to be installed under existing neutral bar

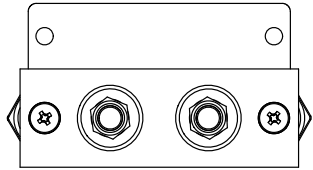

K5985

320 amp

For use with the following series:

1432, 4905, 5155

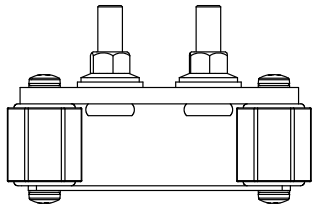

K5985

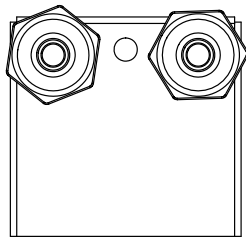

K5986

320 amp

For use with the following series:

4363, 4741, 5052

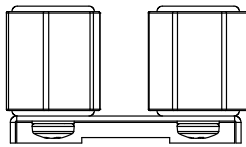

K5986

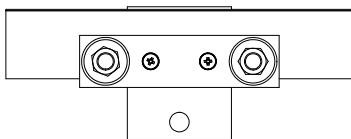

K6024

320 amp

For use with the following series:

3566

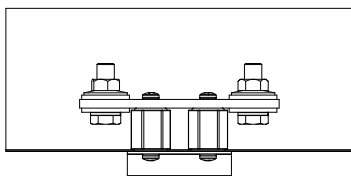

K6024



Utility requirements for this equipment may vary. Always consult the serving utility for their requirements before ordering or installing equipment.